

1. Install Antenna

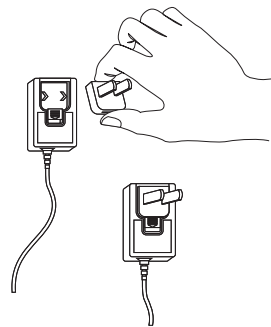

2. Install Adapter Blades

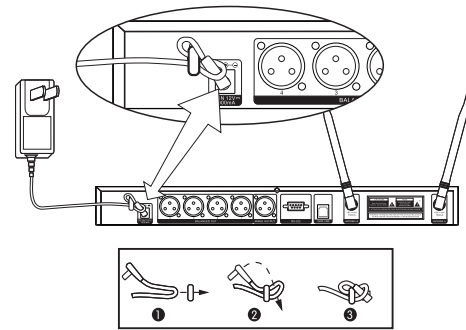

3. Plug Receiver Into DC Power Supply

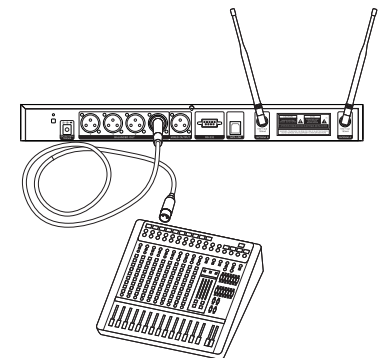

4. Connect Receiver with Audio System

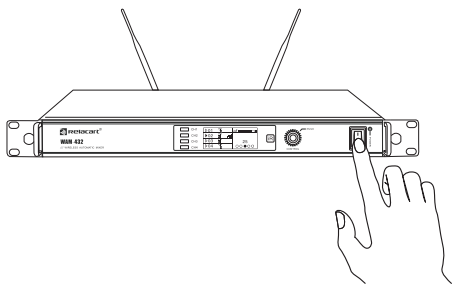

5. Turn on Receiver

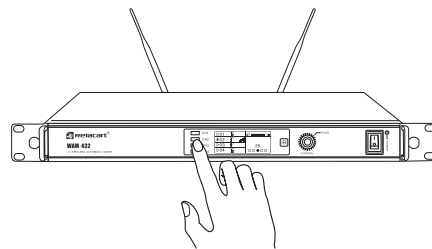

6. Press the channel key one by one, then press the function operation knob to enter the single channel menu settings, find out AFS, and scan out the non-interference frequency

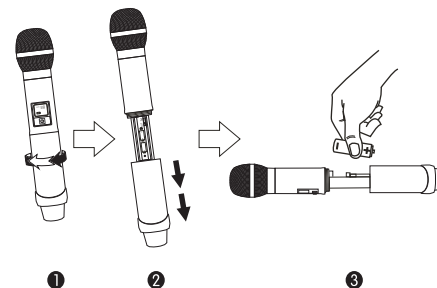

7. Install batteries

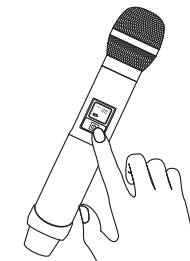

8. Turn on Transmitter

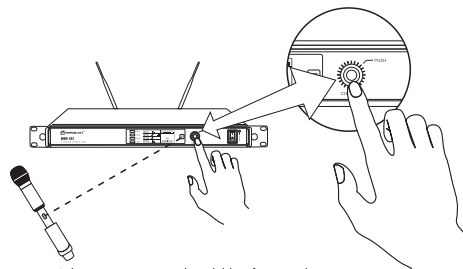

(The transmitter should be facing the receiver, and the optimum synchronization distance is within 1 meter.)

9. Press the channel key one by one, then press the function operation knob to enter the single channel menu settings, find out SYNC and synchronize the frequency to transmitter

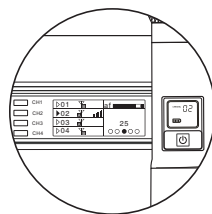

Both the receiver and transmitter display the same frequency

10. Frequency Sync finished

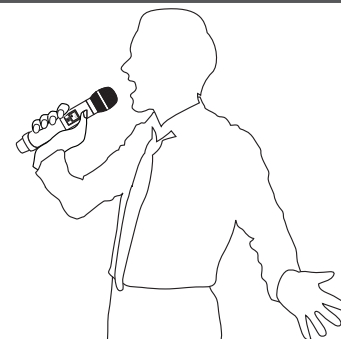

11. Start using the microphone